

Data Sheet



Article number: 5863504810

Description: Ball Valve 350.4810, G 1/2" - G 1/2"
Thread/Thread

Measures

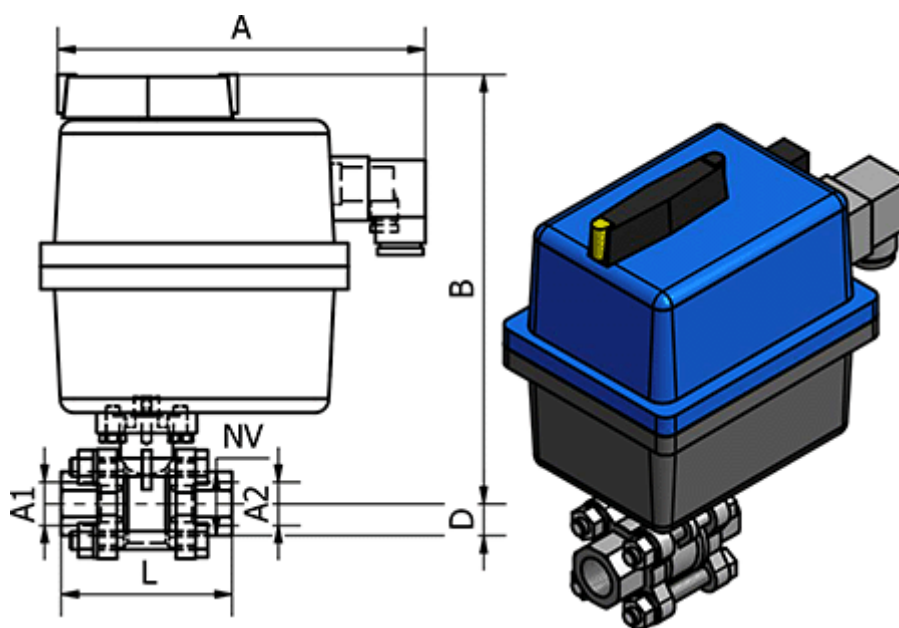

= -	Connecting A2	= G 1/2"
= -	D	= 24
= -	L	= 56
= -	Max. Operating Pressure	= 40 bar
= -	NV	= 29

A = 177

B = 189

Connecting A1 = G 1/2"